

SCALE 2:1

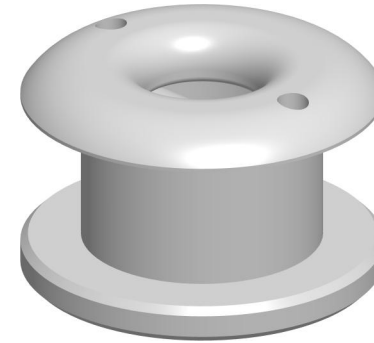

COLOURS AVAILABLE: Blue and Black
Others available upon request with an increased lead time.

Specification

Distance Between Holes mm	Outside Diameter mm	Fixing Hole Diameter mm	Fixing Hole Depth Minimum mm	Fixing Hole Depth Maximum mm	Breaking Load Kg	Maximum Working Load Kg
17	24	16	10	12	400	300

DIMENSIONS FOR REFERENCE ONLY
allenbrothers.co.uk
+44(0)1621 772477

Title	Description
A8739-10-REF	Pad-Tii