

White 225°

CL

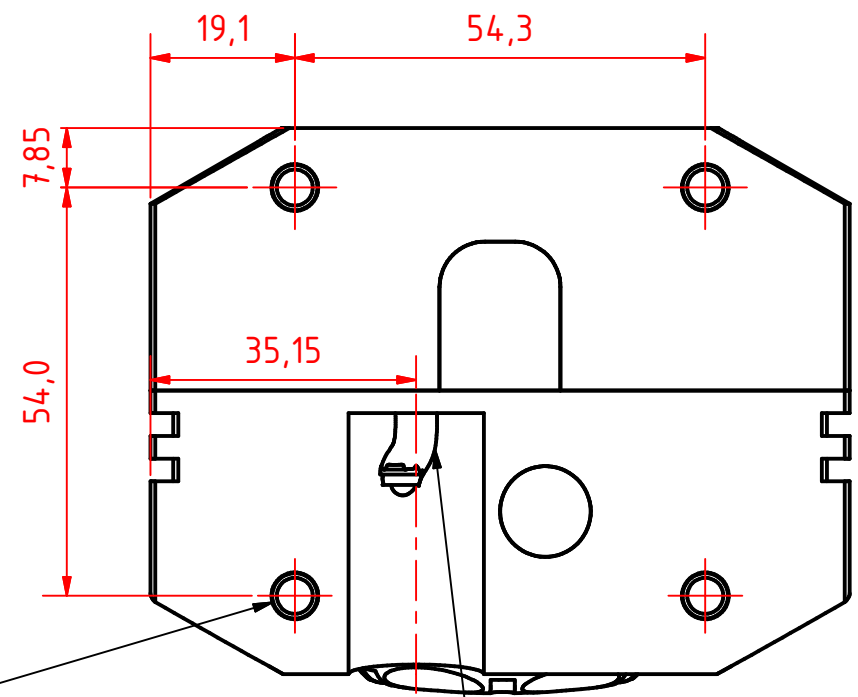
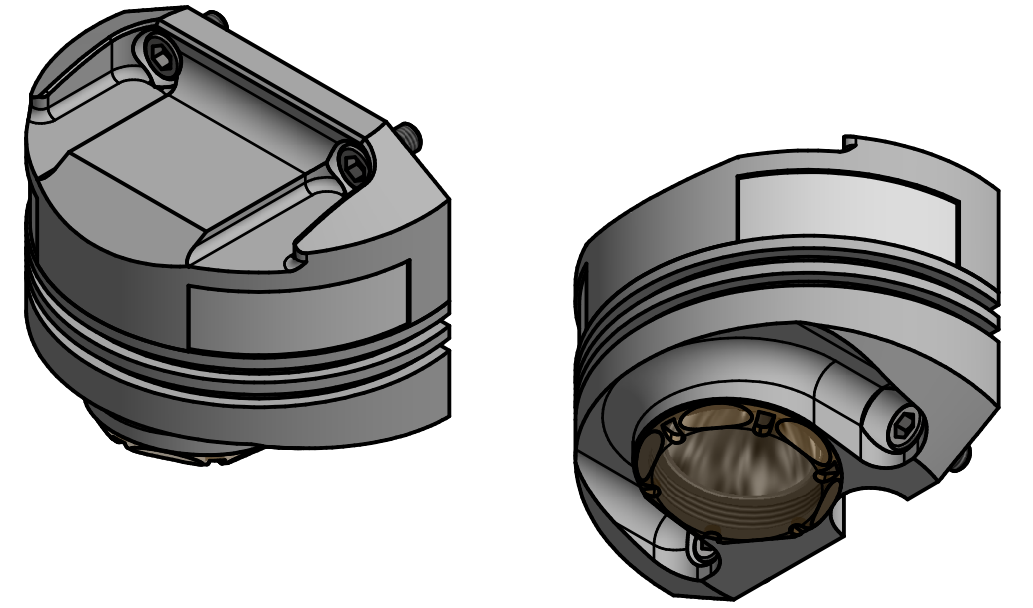
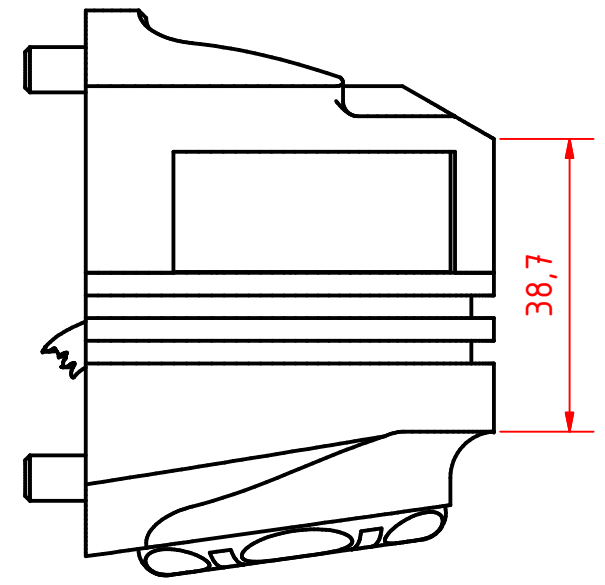

Mounting hole
Ø6,20

Pre-wired Cable Exit Ø5,5mm shielded
marine cable

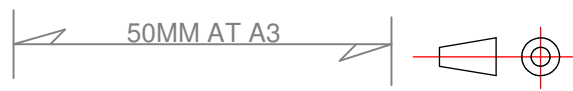

**301-011DLX 5nm masthead Vertical Mount
with Deck Light**

DRAWING NO.: 301-011AE	REV. NO.: 0	SIZE: A3	DRAWN BY: Sergio
SCALE: 1:1	TOLERANCES: DS/ISO 2768-f	REVIEWED BY: PHC	CREATION DATE: 04-10-2018

MATERIAL DESCRIPTION:
Aluminium, Acrylic
(20µ) Silver anodized according to EN ISO 7599
(50µ) Black anodized according to MIL-A 8625F

This Drawing, and the information within, is the property of Lopolight ApS and may not be used in any form without express permission there from. Lopolight reserves the right to change this drawing and assumes no liability for the information communicated herein. Use of dimensions and other information in this drawing is at the users own risk.



Lopolight ApS
Bakkegaardsvej 513
DK-3050, Humlebaek
Denmark
www.lopolight.com

Tel:(+45) 32 48 50 30 Fax:(+45) 32 48 50 32
info@lopolight.com