



**SIMPLY
POWERFUL**

nke
MARINE ELECTRONICS

nke

MARINE ELECTRONICS

For 30 years nke has been developing innovative marine electronics dedicated to sailing. Whatever your program, whether it be racing or cruising, solo or crewed, nke instruments have been designed to answer all your needs and expectations at every level.

We keep performance, reliability, user-friendliness and safety in our focus for research and development as well as for service and information.



© Yvan Zedda

CONTENT

The partners	3
Cruising	4
Racing	6
Offshore Racing	8
Interconnection	10
nke Bus	12
nke Range of Products	14
nke Global Network	16



Thomas Coville, Skipper Ultim Sodebo
Solo Cross-Atlantic Record
Solo Around The World Record

"Thanks to the performance and the reliability of the nke autopilot, I could set a Record Solo Around The World on a multihull"

Thomas Coville

SIMPLE

When on the water your focus is on your environment, sail tuning and crew safety. For your peace of mind we develop user-friendly interfaces for all instruments, with the autopilot our priority.

EFFICIENT

When the time comes to hand the helm over to a "machine", particularly when the weather conditions start to get bad, you need to know the pilot can steer to the course set efficiently and reliably. We do our best to deliver the most reliable, high performing systems you can expect.

SERVICE

Do you have a technical question? Or need advice on installation? Feel free to ask! Our team will help you to diagnose issues remotely and send you the required spare parts anywhere in the world.

Blue Water



> Sébastien ROUBINET > Eric BROSSIER / France PINCZON DU SEL > Team JOLOKIA

Cruising



> James BURWICK > Jean-François EEMAN > Océan Dentiste



> Ptitbout > François GIRARD > Philippe ROUSSEL

Performance



> Michel DESJOYEUX > Thomas RUYANT > Samantha DAVIES



> Thibaut VAUCHEL > Thomas Coville > David RAISON



> Nicolas BOIDEVEZI > Mickael HENNESSY > Ian LIPINSKI



> Jörg RIECHERS > Gaël LE CLEACH > Nikki CURWEN



> Sébastien ROGUES > Paul MEILHAT > Giancarlo PEDOTE

nke

COMMITMENTS FOR STRONG AND LONG-TERM PARTNERSHIPS

We share our passion, through various partnerships, with racing teams, cruising boats and even some unusual challenges.

We have been touched by these women and men and their strong commitment to take-on challenges, for either sport or adventure.

Our commitment means that nke supports every step of their project and contributes to the awareness of sailing, globally and locally.

PARTNERS



CRUISING

You can rely on your nke autopilot in any circumstance. Gyropilot ensures you enjoy the full pleasure of cruising whatever the weather conditions.

Our motto: comfort, user-friendliness and safety.



Autopilot

Comfort: The Gyropilot is constantly steering with precision course keeping in all sea conditions.

Optimum safety: Our autopilot has been proven whilst steering Vendée Globe boats for 95% of the race even in the roughest conditions.

A must have tool: This autopilot is the choice of winners of Vendée Globe, Route du Rhum and Mini-Transat.

Ease of use: One single display, the Multigraphic or the Multidisplay, controls the autopilot while displaying navigation and performance data as well AIS target.



Designed by No Design

Multigraphic

One single display to manage the whole system: control the autopilot, access the navigation data, manage AIS function.

Can display 1 to 6 pieces of data in analogue or digital format

AIS mode, associated to a receiver or a transponder

- Page displayed on the Multigraphic
- List of targets
- List of hazardous targets
- Management of anti-collision alarms

AIS alarms can be controlled from your displays mounted in the cockpit and you are alerted in case of collision danger, with no need to go down to the chart table.

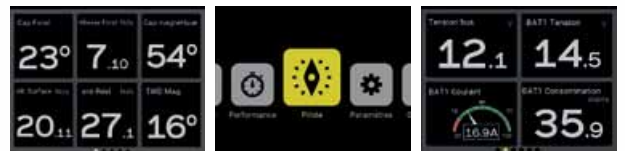

Battery sensor

Essential equipment to manage energy usage on board!

It measures and processes charge and discharge data. Energy flow can be monitored directly from the displays mounted outside in the cockpit.



HF GPS

This high frequency GPS (20 Hz) offers the ultimate response to process True Wind Over Ground data to be used by the autopilot, and to record tracks with high resolution.



© Voilers Boreal

Independence and safety together

Because Safety should never be an optional feature, the nke packs all include safety functions as standard. **nke exclusive:** the nke wireless controls include function controls (Gyropilot, Multifunction, Crew Mate) and Man Over Board.

> Remote Control

The system can include several remote devices (Gyropilot, Multifunction, Crew Mate) that can be worn around the neck or on your arm (light weight), and a radio receiver installed on board which can manage up to 8 remotes.

> MOB function (Man Over Board)

- The M.O.B. procedure is automatically triggered from the remote command and can be manually triggered from the MOB button on any multifunction display.
- Audible alarm (100db) to warn the crew (if the radio receiver is installed).
- Bearing and distance to the event are displayed on every multifunction display
 - > The system sends a M.O.B. sentence via the NMEA output to all compatible navigation software applications such as Adrena - MaxSea - Expedition - SeaPro - ScanNav - Noé.
 - > Output relays can send a command to engine circuit breaker, beacon launcher or any other piece of safety equipment



Rams

> HYDRAULIC RAM

nke has chosen the hydraulic solution for its recognised reliability, power and fast operation. The system includes a reversing pump and a linear ram and it is an investment for the long term. There are 4 models of linear hydraulic rams for boats from 6 to 18 meters.

The Gyropilot is compatible with any kind of drive unit.

> MECHANICAL RAM

- For boats up to 30 feet
- Very low power consumption



CRUISING PACK

Our cruising system is built around the pilot to bring the best comfort and safety. The gyrometer integrated in the Gyropilot's processor ensures quick response and course stability.

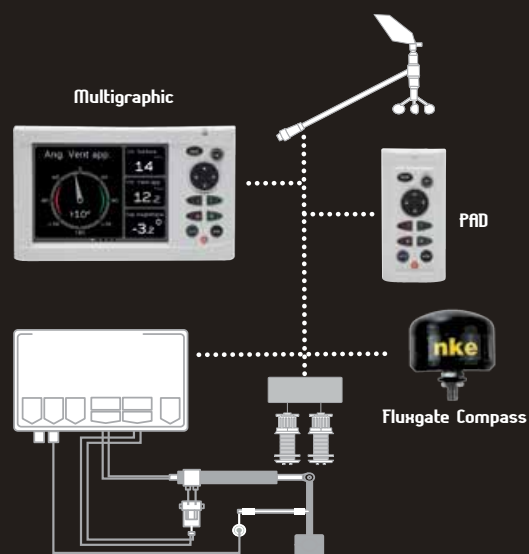

nke SERVICE

The nke team can help you to diagnose issues remotely and send you the required spare parts anywhere in the world.

INTERFACE

FOR THIRD PARTY APPLICATION

See the interconnection section, page 10



RACING

You need the best measured data to process performance and enable good tactical decisions. We have developed a range of accurate, reliable sensors with a redundancy capability built into systems. The True Wind data is processed at 25 Hz thanks to the HR (High Resolution) sensors combined with the Regatta Processor, giving you real time information.



Regatta Processor and 3D Sensor



True Wind like you've never seen it! Enjoy and use True Wind fast rate data: Ten times faster than with another instrument system! Combined with high resolution sensors, the RegattaProcessor processes wind data at 25 Hz and includes a correction for boat accelerations thanks to the 3D sensor. With meticulous calibration, it satisfies the most demanding tacticians.

The 3D Sensor measure boat heading and motion (roll, pitch and yaw). The result is achieved thanks to 3 gyroscopes, 3 accelerometers, 3 magnetometers and a temperature sensor



Multidisplay

This 7" colour screen offers two dedicated pages for racing. The "Tactic" and "Start" pages display all key information in the cockpit for the tactician and the helmsman. Graphic logs of wind data (speed and direction) can also be displayed. This valuable information is useful for reading wind shift.

With a connection to the AIS receiver, an AIS list of the competitors is available on the Multidisplay.

Use the user-defined pages to display all essential information on the Multidisplay in landscape mode. You can set your own pages with 4 racing setups: A, B, C and D. For example: a start configuration with timer, True Wind Speed, Start Line, etc. The configuration setting is adjusted using the PAD.

The Multidisplay can be mounted as a mast base repeater on boats over 40'.

On boats up to 40 feet, it can be mounted vertically (portrait mode) to display 3 functions.

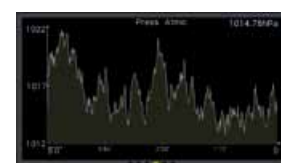

PAD: The Multidisplay remote control

This remote control (wired) features A,-B,-C,-D keys for direct access to pre-set configurations. For instance, after a start using configuration A, just press "B" to toggle all Multidisplay screens to display the useful functions for beating, and then press "C" for downwind functions, and so on...

The PAD also gives access to various menus.





REGATTA "KEY SYSTEM" PACK

Includes the 4 key sensors and a mast mounted display. All you need to get wind and performance data.



REGATTA HR PACK

The next step is to include a HR wind sensor, a Regatta compass and an Ultrasonic speed sensor. These high resolution sensors provide accurate and responsive data.

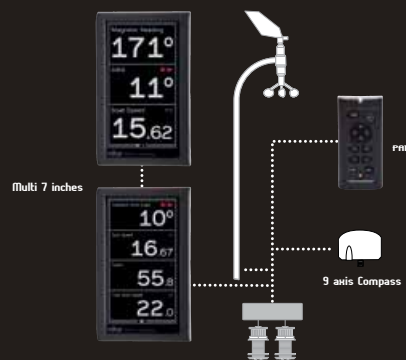

Carbowind HR

This mast head sensor is mounted on a carbon arm exceeding one meter in height to position the wind vane away from turbulence related errors caused by the sails. It integrates high resolution electronics (0.1° and 0.1 knots). True Wind tables are saved in its memory. Mechanically designed to minimize the moment of inertia, its responsiveness makes this wind sensor the best one available on the market. It was the choice for 4 America's Cup teams in 2017.



Ultrasonic Speed Sensor

This flush mounted sensor is one of a kind, with a linear response from 0 to 50 knots. With the ultrasonic technology, it can measure boat speed, be anti-fouled and is free from all issues inherent in other speed sensors.

9-axis Compass

Gyro compensated, it is accurate and responsive. Free from any mechanical part, it is very reliable. The dynamic accuracy is up to 2° at 30° heel angle. It can be connected to the Regatta Processor.



HF (High Frequency) GPS

Measuring the position several times per second enhances the recorded track accuracy and the course marks plotting as well as it gives accurate real time information, such as distance to the start line and time to burn.

Forestay Load Sensor

Keep fine tuning in all conditions. This sensor measures the load on the forestay. Its installation can be carried out with the rig in situ. Any multifunction display can read the load data.



REGATTA PROCESSOR PACK

For the most demanding tacticians, the fully configurable processor provides high level measurement and calculation of wind data.

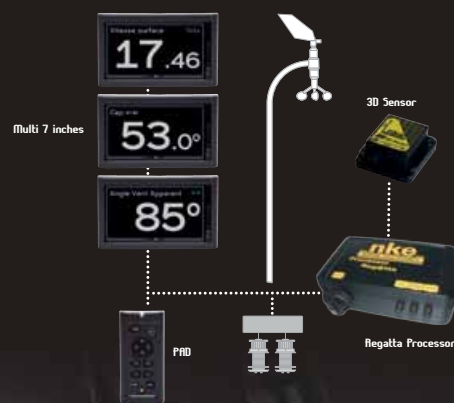

OFFSHORE RACING

nke is a globally known brand of autopilot, as demonstrated by the last records achieved by Thomas Coville with the Sodebo Ultim trimaran; in addition the number of nke equipped boats in classes such as IMOCA, Class 40, Mini 650 and among IRC boats (single-handed and double-handed). Not forgetting that the Figaro Class members have largely again approved the choice of the nke pilot for the new Figaro Bénéteau 3. The autopilot performance significantly contributes to the overall performance of the boat and it is probably more valuable than any design modification (and certainly more cost effective).



HR Processor and HR



The base is a HR processor integrating a new algorithm combined with an inertia unit providing the boat's motion data at 25 Hz.

This 3D pilot integrates roll and pitch to steer the boat. By including the heel angle, the autopilot can handle more.

The HR Pilot V3 integrates a Gust Mode to manage gusts and a Surf Mode for performance. Approved by Thomas Coville (Solo Around The World Record holder) and Frédéric Denis (winner of the Mini Transat 2015), this new generation of HR autopilot has received the "Prix de la Haute Technologie" (High Technology award).

GPS Compass



This satellite compass is the solution to eliminate deviation and therefore calibration. With two satellite receivers and a connection to the 3D Sensor Fusion, it provides an accurate heading. It is responsive and robust.

Such a system is very well appreciated in the southern seas where magnetic devices perform less well.

9-axis Compass

For heading data, the Regatta Compass, a stabilized gyrocompass integrating 9 sensors, provides heading, heel and pitch data adjusted from the turn rate and acceleration.

The heading is used instantly by the Gyropilot. The autopilot performance immediately benefits when the pilot is engaged.

HR Carbowind

With the Carbowind the sensor's head is placed 1.10 m above the mast head. This is crucial to clear the sensor from the mainsail (particularly with square head) and the spinnaker. The design of this wind sensor makes it the most responsive on the market. It was the choice of 4 teams in the last America's Cup.

Gyropilot

A unique reference in sailing from Mini 6.50 m up to 100 footers. The gyro-meter comes as standard with an integrated energy saving feature. It is compatible with all drive units available on the market. This is the model which has contributed to 3 victories in the Vendée Globe

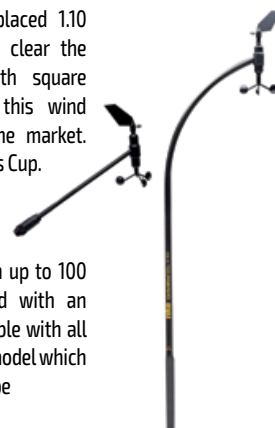

AUTOPILOT AS A TOOL FOR **PERFORMANCE**



© Pierre Bouras

III Drive unit

nke offers robust and responsive hydraulic rams which are sized according to the rudder's surface area and the boat's speed.

III Remote control with integrated MOB

With over 3 years lifespan, this light remote control can be worn permanently. While sailing with a crew, the action on the pilot in case of Man Over Board can be disabled..



III Ultrasonic Speed Sensor

For boat speed we recommend the Ultrasonic sensor. It installs flush and its measurement is linear from 0 to 50 knots.

III HF GPS

With high rate data at 20 Hz, the HF GPS offers an alternative boat speed input in the calculation of true wind. It is more responsive than a conventional speed sensor.



III Apparent Wind Monitor

Improves the autopilot steering thanks to high quality wind data. It provides a real time clean wind data.



III Mast Angle

This sensor is essential for rotating masts and crucial for wind data processing. Two versions are available: inductive or mechanical.



RACING "KEY SYSTEM" **PACK**

Get the performance level required for racing at an affordable price. This means an autopilot that steers in true wind mode to follow wind shifts and reach as much as possible 100% performance.

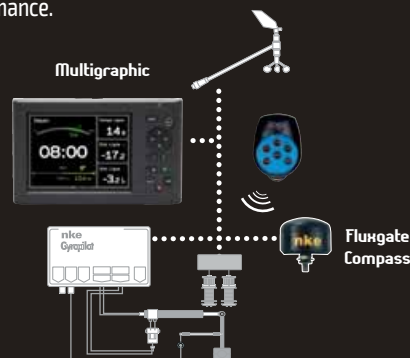

PERFORMANCE RACING **PACK**

This pack includes the High resolution sensors (HR). They provide the accuracy and response required for a performance autopilot.

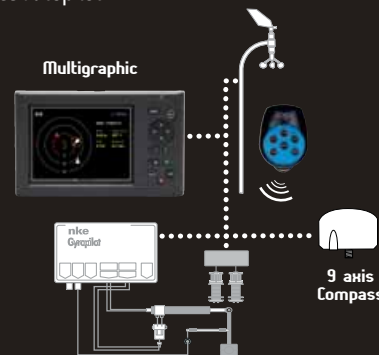

RACING HR PROCESSOR **PRO PACK**

The wind minded Regatta Processor acquires data at 25Hz and provides accurate noise-free wind figures adjusted for the boats' acceleration thanks to the 3D sensor. The wind data is accurate and provided with fast updates. The Gyropilot works better and with less energy consumption.

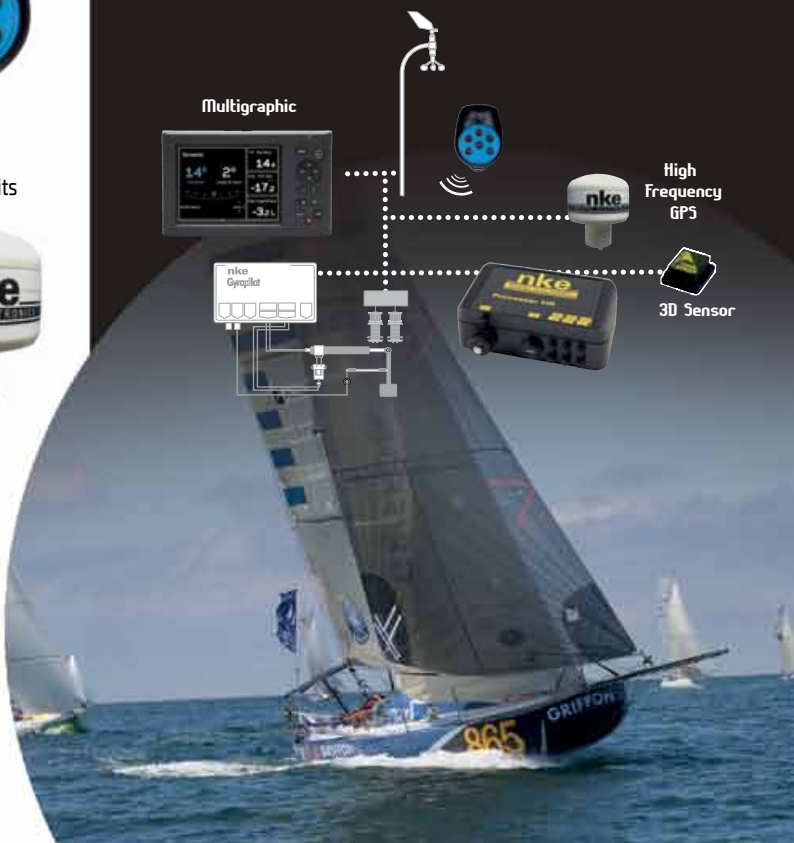

INTER CONNECTION

The nke instruments communicate with each-other via their own bus. Many other devices on board can take advantage of a connection to the nke bus. To do so, two standard protocols are available for wired or wireless (WiFi) data communication: NMEA0183 and CAN.

We have created relevant interface boxes to cover most needs.



||| Connection to a Chartplotter

NMEA 0183 and/or CAN compatible

> THE COMPATIBLE BOXES

Compatible with all boxes, but consider the CAN Box if your chartplotter does not feature NMEA0183 input and output.

> WHAT USE

Data from the nke bus can help with navigation on a chartplotter. Data such as wind speed and angle, boat speed, depth, atmospheric pressure, and more can be provided depending on the sensors installed. You can also benefit from the navigation data coming from your chartplotter on the nke displays. Heading, bearing and distance to the next waypoint or XTE can be displayed and used by your autopilot in the GPS mode.

CAN BUS: Data exchange protocol between CAN compatible devices

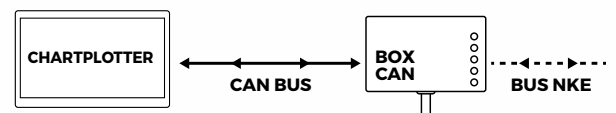

||| Instruments and sensors from other brands

NMEA 0183 and/or CAN compatible

> THE COMPATIBLE BOXES

Compatible with all boxes, but particularly the WiFi and CAN boxes. The devices from brands other than nke must feature the required inputs / outputs interface.



||| Connection to a computer

USB, NMEA 0183, Ethernet and WiFi

> THE COMPATIBLE BOXES

All, but the USB Box has the advantage of a robust connection, easy to set up and it avoids the use of a serial/USB converter or a computer featuring a serial port. The nke software Toplink can be used with the USB Box. It allows the updating of instruments and the running of advanced diagnostics on the installed system.

> WHAT USE

Like the chartplotters, navigation software can read and use the data coming from the nke bus and send navigation data to the bus. They often feature more advanced functions. For example, a software dedicated to performance sailing, like Adrena, Expedition Marine or MaxSea, can allow you to create specific "Performance" or/and "Dynamic" channels on the bus. The data calculated by the software is exported to the nke Bus. Therefore, the system can display functions such as: optimum boat speed, heading on the next tack, optimum angle to windward, upwind/downwind VMG, etc.

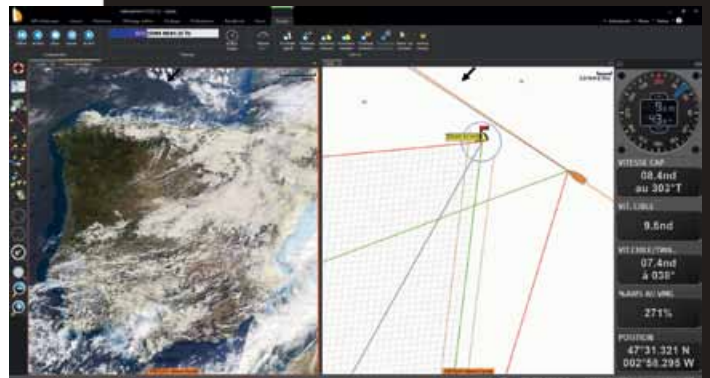
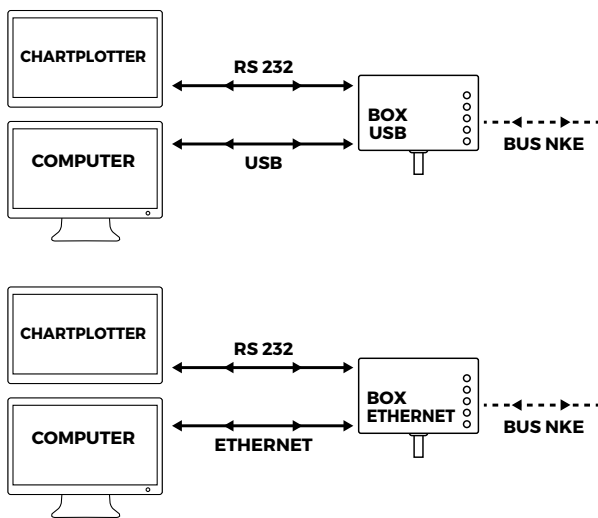

||| Tablets and Smartphones

WiFi Connection

> THE COMPATIBLE BOXES

WiFi box, USB box (only in some cases). Various applications are available these days for navigation. These Boxes use standard open protocols allowing the use of most software packages available on the market.

> WHAT USE

Mainly for marine cartography applications. AIS data can be multiplexed with the bus data to get all information in a single data flow. The application "nke Display" for iPhone/iPad/Android allows to display and save data.

Data are communicated in the NMEA 0183 format.

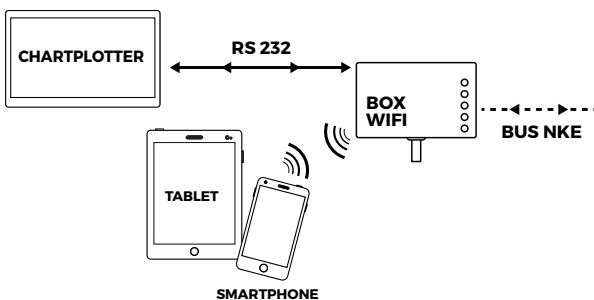

TOPLINK

The Toplink software can be used to manage and maintain nke instruments. It is developed for PC running Windows 95 to 10 versions.

It offers the following functions:

- Analysis of your system (list of instruments).
- nke devices firmware update.
- Read cookies on nke devices.
- Record nke Bus data for analysis.

This software can be used with the USB Box and you can run your system's update by yourself. This is particularly valuable for blue water sailing and in remote areas.

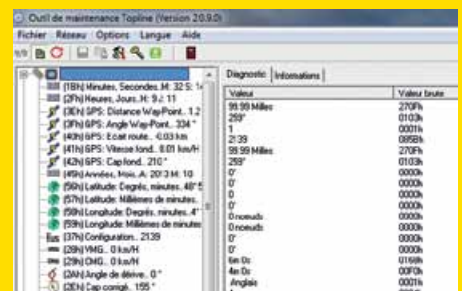

BUS nke

SUGGESTIONS FOR SYSTEM CONFIGURATION

Easy installation

The nke three wires cable is easy to install. With no connector it can be run in any location.

Upgradable

Adding instruments to an existing system is a piece of cake! Any component can be added to the system by simple connection to the bus anywhere.

A 'key system' (standard sensors and a multifunction display) can be expanded to a full system following your needs (GPS, specific sensors, autopilot, etc.) and your performance requirements (HR sensors, Regatta processor, etc.)

Robust

No central unit. Any Multifunction Display can process data on the bus. If the master display happens to fail, just choose another one as the master.

Lightweight

In some cases we use avionic cables with a weight of 17 g/m. We can also provide a quotation for weight and power consumption subject to request for a specific system installation.



© David Wallace

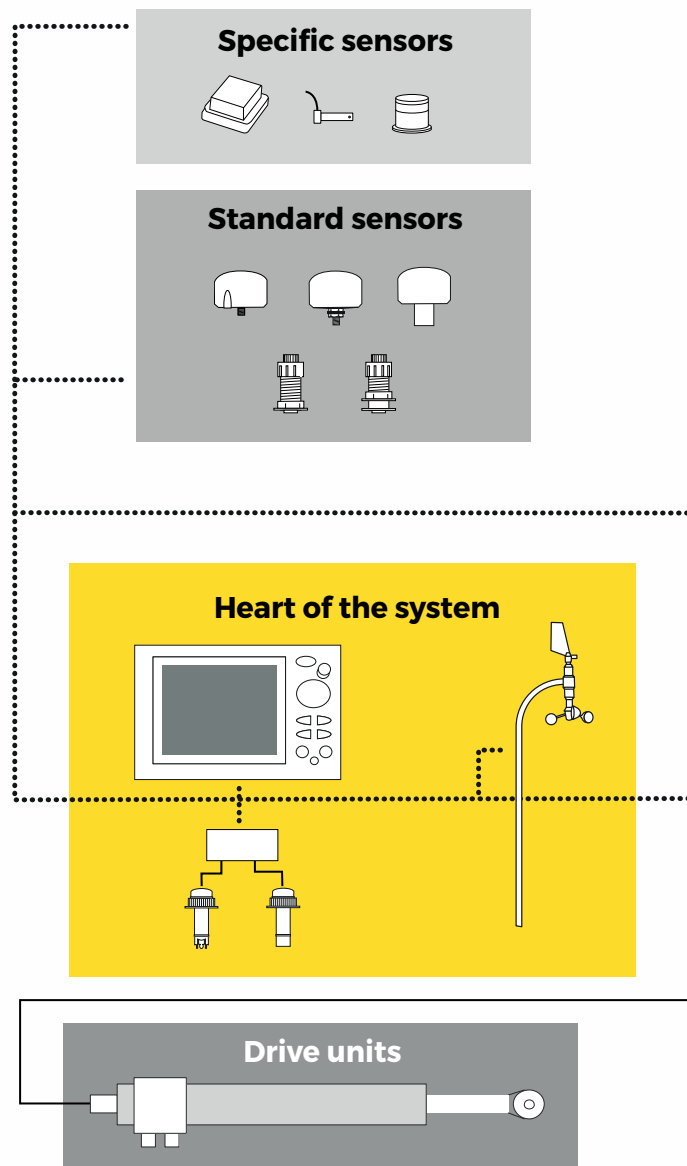



Dedicated displays and multifunction displays

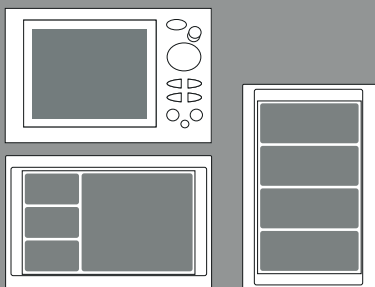

Regatta or HR Processor

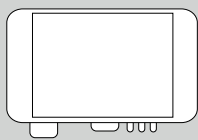

Autopilot

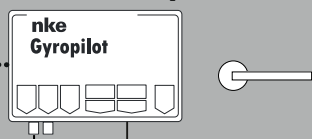

Wireless remot control



Joystick (Tiller)

Hydraulic ram

nke has chosen the hydraulic solution (for boats over 30 feet) for its recognised reliability, power and fast operation. The system includes a reversing pump and a linear ram for extended reliable service. With this system nke ensures firm steering in all conditions with optimum efficiency. The Gyropilot can also power any hydraulic pump drive unit at constant run (CRP), generally used on bigger boats.

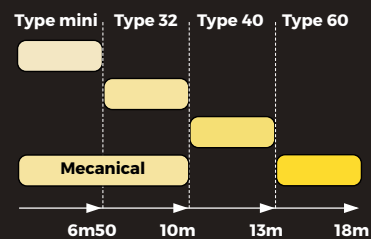

> THE MOST RELIABLE DRIVE UNIT

The power is calculated to match the pressure on the rudders. Rudder surface, compensation and rudder end stop angles are required to make the calculation.

> OTHER POWER UNITS

The Gyropilot processor is compatible with many other drive units and rudder angle sensors.

You can choose a mechanical ram, a rotary drive or a wheel drive. If the drive can be disengaged, we recommend that a nke specialist is consulted to help you define the right solution and any options including the choice of rudder feedback.

DISPLAYS

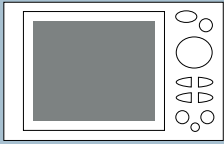

> MULTIGRAPHIC

- > Dimensions [H x L x D]: 118 x 192 x 23 mm
- > Consumption: 90 mA without backlighting and 150 mA with backlighting.
- > IP Protection rate: IP67
- > Vision angle: Horizontal > 160° - vertical > 120°
- > Weight: 750 g (without cable)
- > Cable: 5 m - 40 g/m

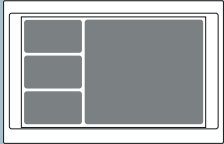

> MULTI 7 INCHES (LANDSCAPE MODE)

- > Dimensions [H x L x D]: 118 x 192 x 23 mm
- > Consumption: 90 mA without backlighting and 150 mA with backlighting.
- > IP Protection rate: IP67
- > Vision angle: Horizontal > 160° - vertical > 120°
- > Weight: 780 g (without cable)
- > Cable: 5 m - 40 g/m

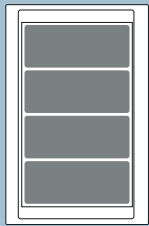

> MULTI 7 INCHES (PORTRAIT MODE)

- > Dimensions [H x L x D]: 192 x 118 x 23 mm
- > Consumption: 90 mA without backlighting and 150 mA with backlighting.
- > IP Protection rate: IP67
- > Vision angle: Horizontal > 160° - vertical > 120°
- > Weight: 780 g (without cable)
- > Cable: 5 m - 40 g/m

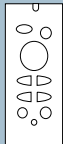

> PAD DISPLAY

- > Dimensions [H x L x D]: 118 x 58 x 23,3 mm
- > Consumption: 50 mA
- > IP Protection rate: IP67
- > Weight: 190 g (without cable)
- > Cable: 6 m - 40 g/m

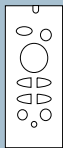

> PAD PILOTE

- > Dimensions [H x L x D]: 118 x 58 x 23,3 mm
- > Consumption: 50 mA
- > IP Protection rate: IP67
- > Weight: 190 g (without cable)
- > Cable: 6 m - 40 g/m

COMPASSES AND GPS



> 9-AXIS COMPASS

- > Dimensions (Ø x H): 78 x 60 mm
- > Consumption: 25 mA
- > Resolution: 0.01°
- > IP Protection rate: IP67
- > Weight: 200 g (without cable)
- > Cable: 6 m - 40 g/m



FLUXGATE COMPASSES

- > Dimensions (Ø x H): 70 x 41,8 mm
- > Consumption: 25 mA
- > Resolution: 1°
- > Weight: 200 g (without cable)
- > Cable length: 6 m



HIGH FREQUENCY GPS

- > Dimensions (Ø x H): 72 x 50 mm
- > Type GPS: 65 Channels
- > Max. power: 600 mW
- > Max. data acquisition rate: 20 Hz
- > Position accuracy: 2,5 m CEP
- > Protocol: Topline + NMEA0183
- > Max. consumption: 50 mA
- > Weight: 150 g (without cable)
- > Cable length: 10 m

WIND SENSORS



> CARBOWIND HR

- > Consumption: 25 mA
- > Angle resolution: 0.1°
- > Height of carbon arm: 110 cm
- > Carbon tube: External Ø22 mm Internal Ø18
- > Weight: 600 g
- > Avionic cable: L 25 m (#:90-60-381) L 35 m (#:90-60-351). Weight: 17 g/m.

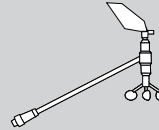

> STANDARD AND HR WIND SENSOR

- > Consumption: 25 mA
- > Angle resolution: 1° (0.1° en HR)
- > Weight: Sensor head: 180 g
- > Mounting plate and bracket: 160 g
- > Cable: L 25 m (#:90-60-092) L 35 m (#:90-60-297). Weight: 34 g/m.



> ALUWIND

- > Consumption: 25 mA
- > Angle resolution: 1°
- > Height of carbon arm: 70 cm
- > Carbon tube: External Ø20 mm Internal Ø18
- > Weight: 600 g
- > Cable: L 25 m (#:90-60-381) L 35 m (#:90-60-351). Weight: 17 g/m.

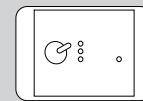

> APPARENT WIND MONITOR

- > Dimensions [H x L x P]: 90 x 160 x 50 mm
- > Consumption: 65 mA
- > IP Protection rate: IP54
- > Weight: 430 g (without cable)
- > Cable: 6 m - 40 g/m

SPEED AND DEPTH SENSORS



> PADDLE-WHEEL SPEED SENSOR

- > Speed measurement range: 0 à 50 nœuds
- > Temp. measure range: 0°C à +50°C
- > Weight: 300 g (avec câble)
- > 6 metres cable featuring moulded connector.
- > Thru-hull housing 1.8" (#31-35-001) - Internal Ø: 31 mm



> ULTRASONIC SPEED SENSOR

- > 2 metres cable featuring moulded connector for the sensor
- > IP Protection rate for the interface box: IP54
- > 4 metres cable featuring moulded connector for the interface box.
- > Speed measurement range: 0 to 35 knots.
- > Temp. measure range: 0°C to +50°
- > Weight: 600 g (with cable)
- > Thru-hull housing (#:31-35-001) : Internal Ø 31 mm



> ELECTROMAGNETIC SPEED SENSOR

- > Speed measurement range: 0 to 50 nœuds
- > Temp. measure range: 0°C to +50°C
- > Weight: 300 g (avec câble)
- > Câble de 6 m avec connecteur surmoulé.
- > Thru-hull housing 1.8" (#90-60-344) - Internal Ø: 31 mm



> DEPTH SOUNDER

- > Depth range: tested up to 50 metres
- > Weight: 350 g (with cable)
- > 6 metres cable featuring moulded connector
- > Thru-hull housing 2" (# 31-35-002). Internal Ø 40 mm

PROCESSORS AND RELATED SENSORS



> HR PROCESSOR

- > Dimensions [H x L x P]: 200 x 110 x 60 mm
- > Consumption: 277 mA (3,3W sous 3.3V)
- > Weight: 500 g
- > Power supply: 9-18 V
- > IP Protection rate: IP67

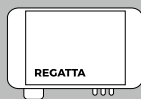

> REGATTA PROCESSOR

- > Dimensions [H x L x P]: 200 x 110 x 60 mm
- > Consumption: 277 mA (3,3W sous 3.3V)
- > Weight: 500 g
- > Gamme de tension d'Power supply: 9-18 V
- > IP Protection rate: IP67



> 3D SENSOR

- > Dimensions [H x L x P]: 110 x 56 x 39 mm
- > Consumption: 30 mA
- > IP Protection rate: IP67
- > Weight: 200 g



> 3D FUSION

- > Dimensions [H x L x P]: 110 x 56 x 39 mm
- > Consumption: 40 mA
- > IP Protection rate: IP67
- > Weight: 200 g

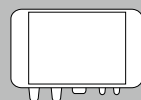

> GPS COMPASS

- > Dimensions [H x L x P]: 90 x 160 x 50 mm
- > Consumption: 65 mA
- > IP Protection rate: IP54
- > Weight: 430 g (without cable)
- > Cable: 6 m - 40 g/m

AUTOPILOT



GYROPILOT

- > Dimensions [H x L x P]: 210 x 134 x 42 mm
- > Consumption: 50 mA au repos (sur « stop »)
- > Power supply: 10 à 16VDC
- > Alimentation sur la puissance en 24 V ou 12 V
- > IP Protection rate: IP67
- > Weight: 1kg, câble compris



RUDDER FEEDBACK

- > Dimensions [Ø x H]: 50 x 29 mm
- > Power supply: 10 - 16 V
- > Consumption: 15 mA
- > Résolution : 0,1°
- > Cable length: 6 m - 40 g/m
- > Weight: 330 g (without cable)



JOYSTICK

- > Dimensions [H x L x P]: 82 x 42 x 42 mm
- > IP Protection rate: IP65

REMOTE CONTROLS



> GYROPILOT

- > Dimensions [H x L x P]: 82 x 64 x 23 mm
- > Power supply: par pile lithium 3.6V
- > IP Protection rate: IP68
- > Weight: 65 g



> DISPLAYS

- > Dimensions [H x L x P]: 82 x 64 x 23 mm
- > Power supply: par pile lithium 3.6V
- > IP Protection rate: IP68
- > Weight: 65 g



> CREW MATE

- > Dimensions [H x L x P]: 82 x 64 x 23 mm
- > Power supply: lithium battery 3.6V
- > IP Protection rate: IP68
- > Weight: 65 g

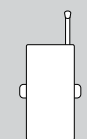

> RADIO RECEIVER

- > Dimensions [H x L x P]: 120,5 x 56 x 31 mm
- > IP Protection rate - Housing : IP20 (not waterproof)
- > Weight: 260 g (without cable)
- > Cable: 3 m

INTERFACE BOXES

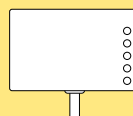

> BOX USB

- > Dimensions [H x L x P]: 56,4 x 110 x 26 mm
- > Power supply: 8V - 32V
- > Consumption: 50 mA
- > Cable length: 3 m - 32 g/m
- > Weight: 20 g

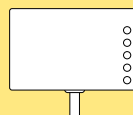

> BOX ETHERNET

- > Dimensions [H x L x P]: 56,4 x 110 x 26 mm
- > Power supply: 8V - 32V
- > Consumption: 50 mA
- > Cable length: 3 m - 32 g/m
- > Weight: 20 g

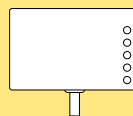

> BOX CAN

- > Dimensions [H x L x P]: 56,4 x 110 x 26 mm
- > Power supply: 8V - 32V
- > Consumption: 50 mA
- > Cable length: 3 m - 32 g/m
- > Weight: 20 g

SPECIFIC SENSORS

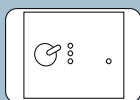

> BATTERY MONITOR 500

- > Dimensions [H x L x D]: 56,4 x 110 x 26 mm
- > Power supply: 8V - 32V
- > Consumption: 50 mA
- > Cable length: 3 m - 32 g/m
- > Weight: 20 g (without cable and without shunt)

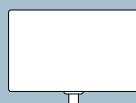

> BARO HR 100

- > Dimensions [H x L x D]: 56,4 x 110 x 26 mm
- > Power supply: 8V - 32V
- > Consumption: 50 mA
- > Cable length: 6 m - 37 g/m
- > Weight: 20 g



> MAST ANGLE

- > Dimensions [Ø x H]: 73 x 63,5 mm
- > Power supply: 10 - 16 V
- > Consumption: 15 mA
- > Resolution: 0,1°
- > Cable length: 6 m - 40 g/m
- > Weight: 450 - 550 g (vary with mounting options)



> FORESTAY LOAD

- > Dimensions (Ø x L): 12,7 x 32 mm up to 35 x 89 mm
- > Max. load: 52 to 430 kN

nke GLOBAL SERVICE

Do you have a technical question? Or need advice on installation? Trained by the nke team, our experts will take action to help you anywhere in the world..

Check our distributors on www.nke-marine-electronics.com/dealer-network/

2 ANS
DE GARANTIE

Follow nke Marine Electronics on:



LinkedIn



6, Rue Gutenberg, ZI de Kerandré
56700 Hennebont - FRANCE

Customer service info.marine-electronics@nke.fr
Tel. 33 (0)2 97 36 56 85

Technical support support.marine-electronics@nke.fr

www.nke-marine-electronics.com