

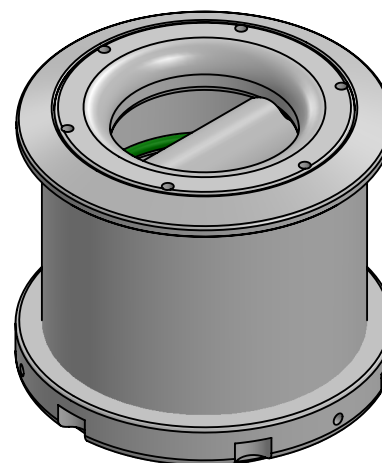

SECTION B-B

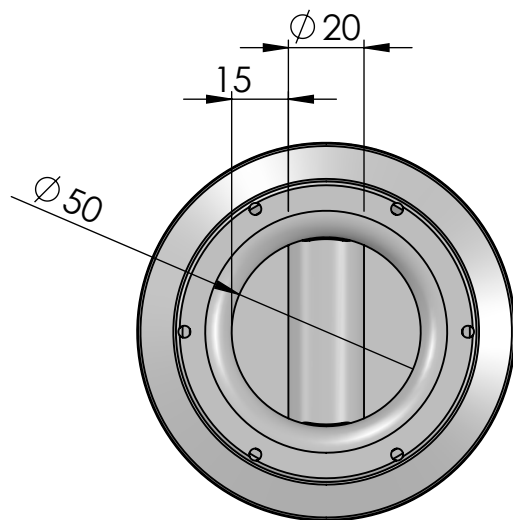

Max working load: 7000kg  
Weight: 1410g

Data Sheet	
Model	FPD7t-x
Line	 ACCESSORIES
Format size	A4
<small>This document and the design on it is the exclusive property of Ubi Maior Italia and is the subject of copyright. Brand by Dini s.r.l., Meccanica di precisione</small>	
